

| REVISION HISTORY |             |      |          |
|------------------|-------------|------|----------|
| Rev              | DESCRIPTION | DATE | APPROVED |
|                  |             |      |          |
|                  |             |      |          |
|                  |             |      |          |

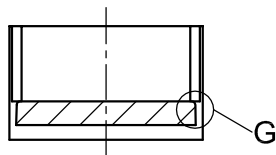

Section E-E

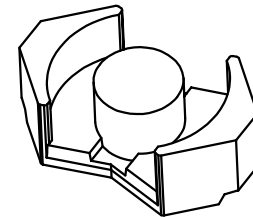
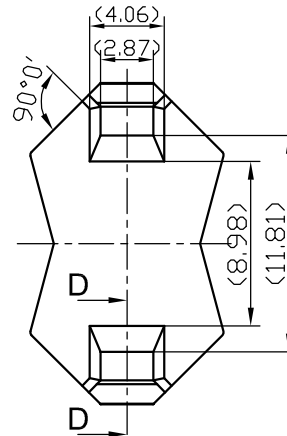
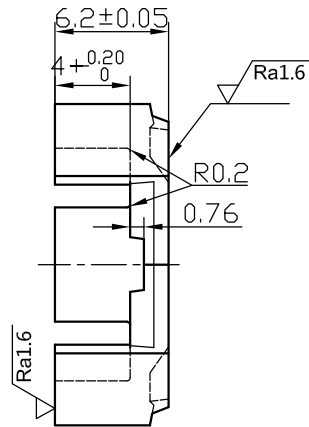
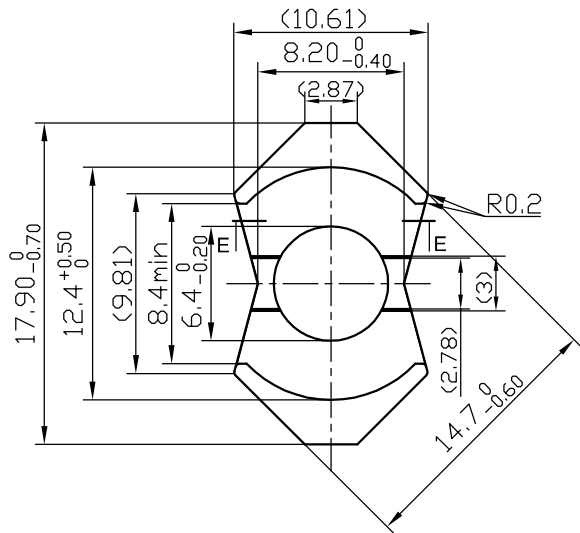
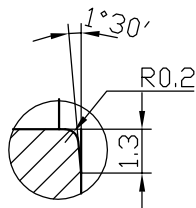

Detail G

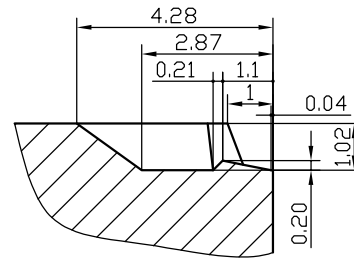

Section D-D

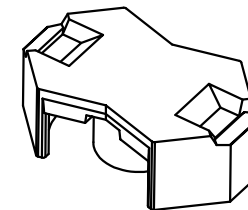

|   |                     |                    |                      |             |
|---|---------------------|--------------------|----------------------|-------------|
|   | Scale               | Material           | Customer Part number |             |
|   | 2.5 : 1             |                    |                      |             |
| Unit:   | Standard tolerances | Product Name       |                      |             |
| mm  | ±0.1                | RM-6S              |                      |             |
| Approved by                                   | Created by          | Document type      | Rev                  | Drawing No. |
| Y.Higuchi                                     | H.Huang             | Production drawing | 00                   | PY170707M10 |
| Hitachi Metals (Hong kong) Ltd. Panyu Factory |                     |                    | Date of issue        | Sheet       |
|   |                     |                    | JUL 7 2017           | 1/1         |